



Part No: GPDCB29F29F-40

5MHz-40GHz, 60V, 2.92mm Female to Female DC Block

Electrical:

Frequency:	5MHz-40GHz
Insertion Loss:	0.5 dB Max
VSWR:	1.30 Max
DC Voltage:	60 Volts
Impedance:	50 Ohms



Mechanical:

Operation Temperature:	-55~+165°C
Storage Temperature:	-55~+165°C
Body Material:	Stainless Steel 303
Center conductor:	BeCu, Golden
Connectors:	2.92mm Female to Female
Relative Humidity:	0 ~ 90%

Outline Drawing:

Unit: mm

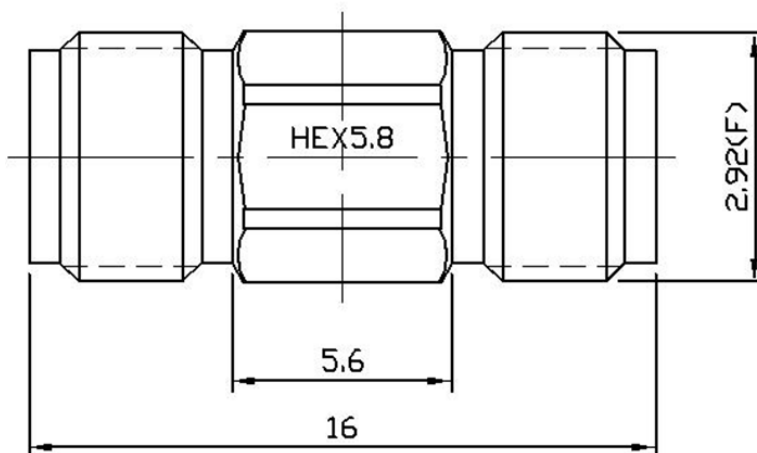

Test curve

